

**Product Data**

Electrical Data	
	SGT (Transmitter)      SGR (Receiver)
Supply voltage	12 – 36 Vdc
Max. Voltage ripple	15 % (within supply range)
Current consumption	100 mA      50 mA
Max. output load	-      200 mA
Reverse polarity protected	Yes
Short circuit protected	Yes
Inductive load protection	Yes

Environmental Data	
Light immunity @ 5° incidence	> 100.000 lux
Temperature, operation	-20 to + 65 °C
Sealing class	Slim Line C-type profile: IP 67 Slim Line A-type & Leading edge B-type profile: IP 54
Marking	CE

Available Models					
	Model	Output	Output Mode	Time-out Function	Sensing Range
Transmitter	SGT 10-xxx-0xx-x1-x-0x-xx	-	-	-	A & C profile: 1 – 10m
Receiver	SGR 10-xxx-0xx-B1-x-06-xx	Solid State Relay	Light/Dark	Yes	B profile: 1 – 7.5 m
	SGR 10-xxx-0xx-x1-x-07-xx			No	

**Connection**

**Wiring Diagrams**



5 pole M12 male connector

Transmitter Model	Black wire connected to (-)	Black wire not connected	Black wire connected to (+)
SGT 10-xxx-0xx-x1-x-00-xx	TX is not transmitting	TX is transmitting	TX is transmitting
SGT 10-xxx-0xx-x1-x-01-xx	TX is not transmitting	TX is transmitting	TX is not transmitting
SGT 10-xxx-0xx-x1-x-02-xx	TX is transmitting	TX is not transmitting	TX is transmitting

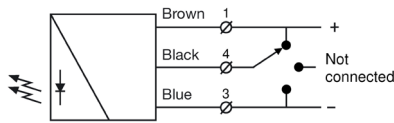

Transmitter SGT 10

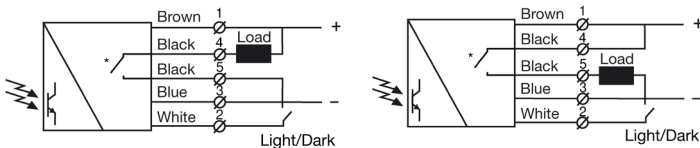

Receiver SGR 10 output as NPN

Receiver SGR 10 output as PNP

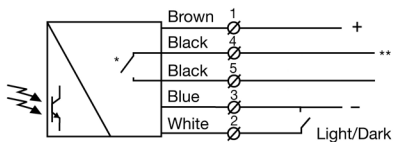

\* Relay type: Open when SGR is not powered      \*\* Max. 24 V ac / 36 V dc

Receiver SGR 10 with solid state relay output.

**Installation & Adjustments**

Adjustment	
No initial set up or adjustments are required, due the automatic signal-tracking (AST) feature, that automatically adjusts the gain of each individual beam on the system.	
Notice that the SG 10 system must not be placed on moving doors.	
1	Mount the transmitter (SGT) and receiver (SGR) facing each other and correctly aligned.
2	Wire the sensor according to the wiring diagram. Make sure the load does not exceed 200 mA.
3	Check for correct wiring before turning power on. Select Light/Dark output mode if required.
4	When the power on indicator (green LED) is on, the system is operating. If the Status indicator (red LED) is constant on the SGR cannot see the SGT.

**Output Logic**

Detection	Output mode	Output status	Output indicator (yellow led)
Present	Dark operated (N.O.) (White wire connected to Blue wire)	Closed	On
	Light operated (N.C.) (White wire disconnected)	Open	Off
Absent	Dark operated (N.O.) (White wire connected to Blue wire)	Open	Off
	Light operated (N.C.) (White wire disconnected)	Closed	On

**Time-out Function**

On models with timeout function up to 3 non-adjacent channels can be ignored when obstructed for more than 10 seconds:

Receiver Model	Non-adjacent channels which can be ignored
SGR 10-xxx-028-B1-x-06-xx	3
SGR 10-xxx-024-B1-x-06-xx	2
SGR 10-xxx-020-B1-x-06-xx	2
SGR 10-xxx-016-B1-x-06-xx	2
SGR 10-xxx-012-B1-x-06-xx	1
SGR 10-xxx-008-B1-x-06-xx	1

**Test Input**

The SGT10 transmitter can be externally disabled and enabled via the black control wire for test purposes. When the transmitter is disabled the receiver will switch the output.

**Indicators**

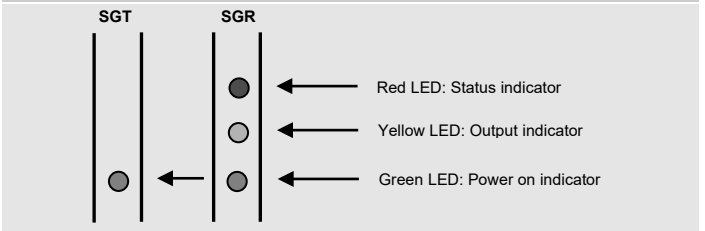

**Troubleshooting**

Probable Reason	Corrective Action
<b>1. Symptom: Status indicator (Red LED) on SGR is constant on.</b>	
TX is not emitting.	Check supply and cable to the SGT.
SGT is disabled.	Enable the SGT.
The upper channel is blocked.	Remove obstruction.
The rails are out of sensing range	Reduce the distance between the rails.
On models with timeout function: Too many channels have been blocked or damaged (time-out function is activated).	Remove obstruction or replace the faulty unit.
<b>2. Symptom: Status indicator (Red LED) is flashing but correct function of light curtain.</b>	
On models with timeout function: time-out function is activated.	Remove obstruction or replace the faulty unit.
<b>3. Symptom: Status indicator (Red LED) is flashing and output is activated in Dark Operated mode. Output is not activated in Light Operated mode.</b>	
On models with timeout function: Two adjacent channels are blocked or damaged.	Remove obstruction or replace the faulty unit.
<b>4. Symptom: Output indicator (Yellow LED) is flashing</b>	
Severe electrical interference.	Separate SGR and SGT supply cable from high voltage cables.
Severe ambient light.	Swap position of SGT and SGR.
Cross talk from another light curtain.	Swap position of SGT and SGR.
Cross talk from a nearby HF strip light	Swap position of SGT and SGR or remove the strip light.
<b>5. Symptom: Status indicator (Red LED) is not lit and output is activated in Dark Operated mode. Output is not activated in Light Operated mode.</b>	
One or more beams are blocked or the rails are out of sensing range.	Remove obstruction or reduce the distance between the rails.



**Warning**  
 This device is not to be used for Personnel Protection in Machine Guarding Safety applications. This device does not include the self-checking redundant circuitry necessary to allow its use in personnel machine guarding stand-alone safety applications.

**Dimensions and Descriptions**

Slim Line "A" Housing – IP 54

Details

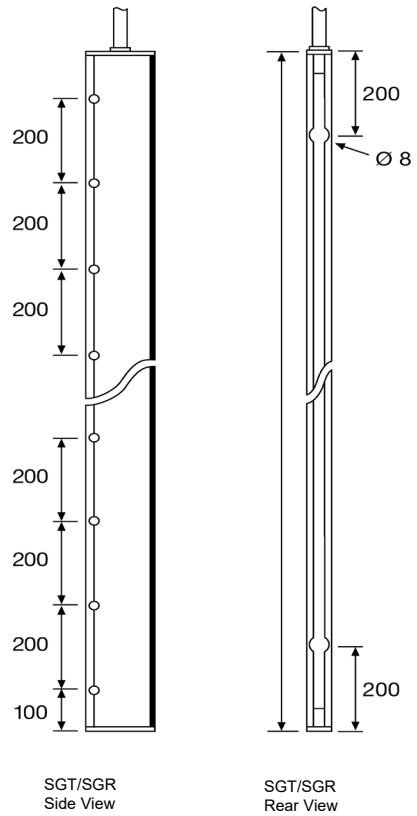
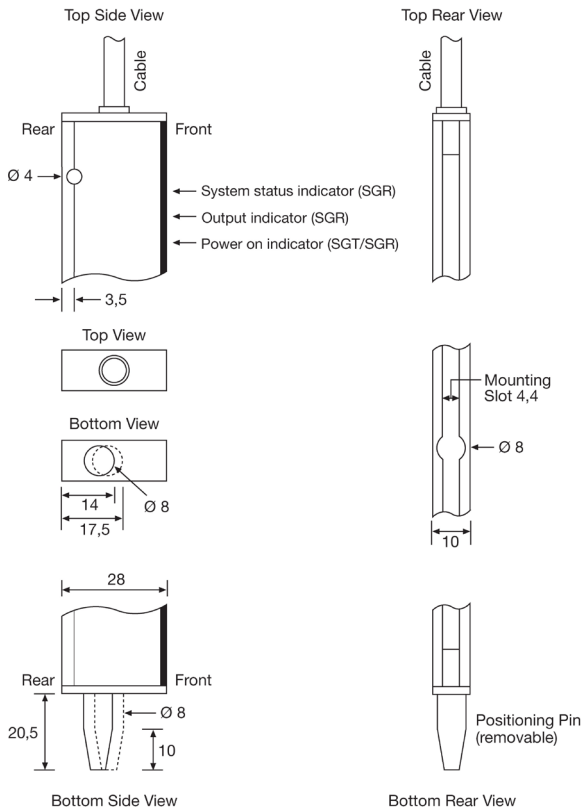

SGT/SGR Side View

SGT/SGR Rear View

Leading Edge "B" Housing – IP 54

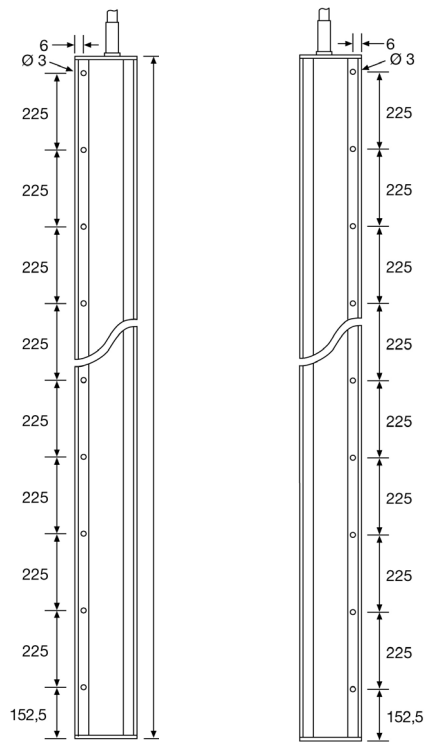
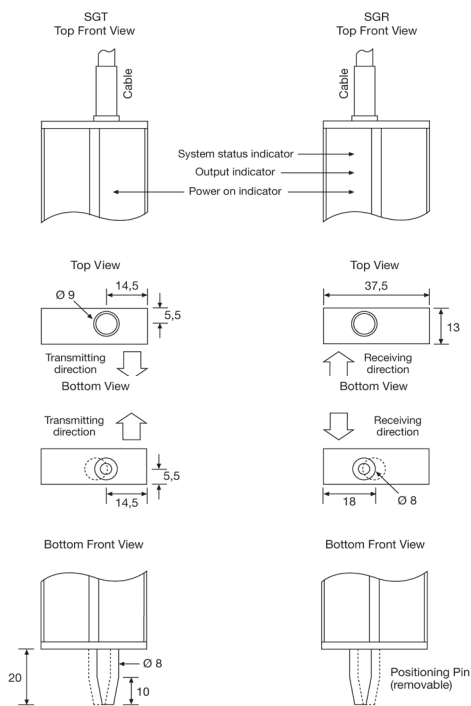

SGR Rear View

SGT Rear View



**Warning**

This device is not to be used for Personnel Protection in Machine Guarding Safety applications. This device does not include the self-checking redundant circuitry necessary to allow its use in personnel machine guarding stand-alone safety applications.

Dimensions and Descriptions

Slim Line "C" Housing – IP 67

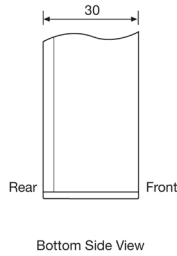
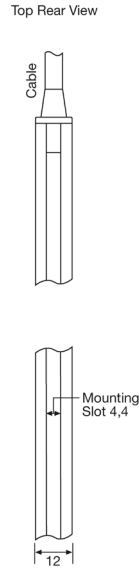
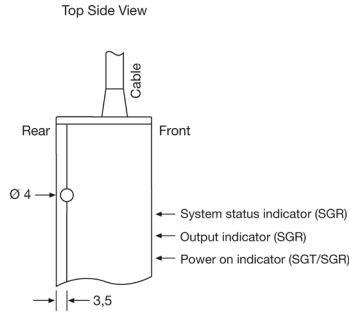

Bottom Rear View

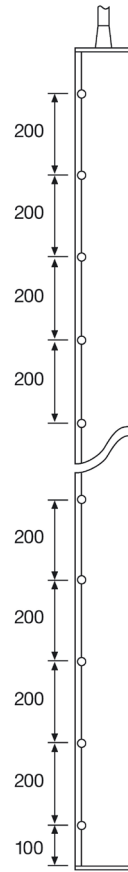

SGT/SGR Side View

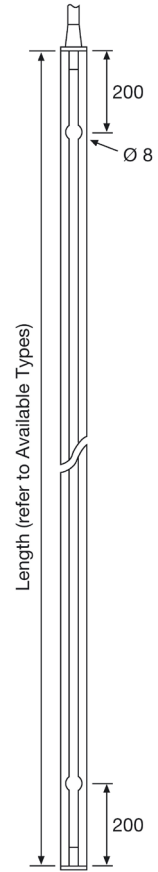

SGT/SGR Rear View

Position of Channels & Channel spacing

46 mm channel spacing  
(Drawing of 2000 mm housing length, 40 channels model)

Housing Length & Number of Channels

92 mm channel spacing  
(Drawing of 2000 mm housing length, 20 channels model)

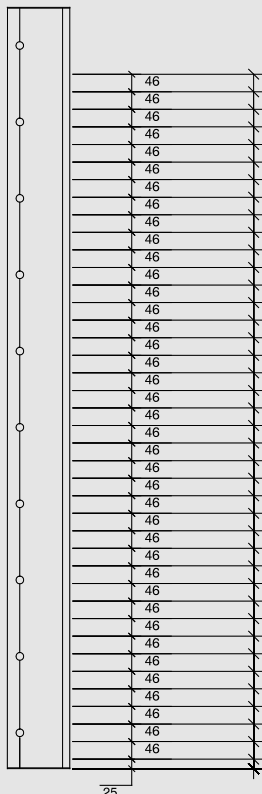

Fig. 1 Units in mm.

Housing Length	Active height	Number of Channels	Channel Spacing
850 mm	669 mm	8	92 mm
	715 mm	16	46 mm
1250 mm	1037 mm	12	92 mm
	1083 mm	24	46 mm
1600 mm	1405 mm	16	92 mm
	1451 mm	32	46 mm
2000 mm	1773 mm	20	92 mm
	1819 mm	40	46 mm

To determine the position of channels on each different model use this table and refer to fig. 1 & 2.

Um die Position der Kanäle auf jedem der unterschiedlichen Modelle festzustellen, benutzen Sie diese Tabelle und beziehen Sie sich auf Bild 1 u.2. Kanal N°1 befindet sich unten.

Pour déterminer la position des canaux sur chaque modèle différent, utilisez cette table et référez-vous à fig. 1 et 2. Canal n° 1 au fond.

Para determinar la posición de los canales en cada modelo, utilice esta tabla y véase fig. 1 y 2.

El canal n° 1 está situado en la parte inferior.

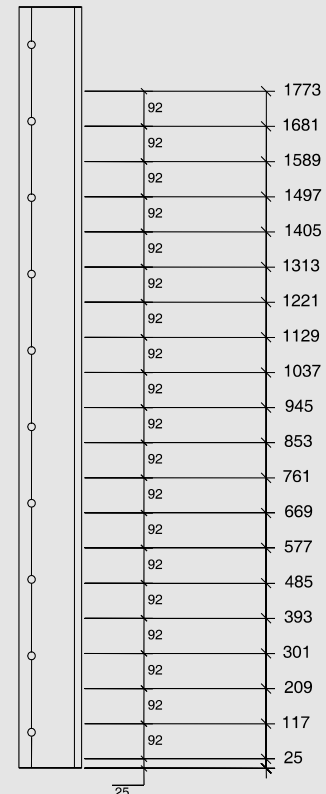

Fig. 2 Units in mm.



Warning

This device is not to be used for Personnel Protection in Machine Guarding Safety applications. This device does not include the self-checking redundant circuitry necessary to allow its use in personnel machine guarding stand-alone safety applications.